

Universal Radio Receiver and Remote Transmitters

Radio Receiver 90-60-250 / *Remote Pilot* 90-60-247 / *Remote Crew* 90-60-251 / *Remote Display* 90-60-248



INSTALLATION GUIDE

V3.3

Zi de Kerandré – Rue Gutenberg – 56700 – HENNEBONT – FRANCE

www.nke-marine-electronics.com

nke

MARINE ELECTRONICS

TABLE OF CONTENTS

1	PRESENTATION.....	3
2	FUNCTIONS OF THE BUTTONS.....	4
2.1	REMOTE PILOT	4
2.2	REMOTE CREW	5
2.3	REMOTE DISPLAY	6
3	MOB SAFETY FUNCTION.....	7
3.1	OPERATION.....	7
3.2	GYROPILOT BEHAVIOUR	7
3.3	THE NMEA OUTPUT	8
3.4	ALARM RELAY	8
3.5	ENABLE AND DISABLE THE MOB FUNCTION.....	8
3.6	AUTOMATIC DEACTIVATION OF THE MOB FUNCTION.	9
3.7	SUSPENDING AND DISABLING THE ALARM	9
4	RECEIVER AND OFFSET ANTENNA INSTALLATION.....	9
4.1	PACKING LIST FOR THE RECEIVER 90-60-250.....	9
4.2	LIST OF ACCESSORIES	9
4.3	SPECIFIC PRECAUTIONS FOR THE INSTALLATION OF THE RADIO SYSTEM.....	10
4.4	SPECIFIC PRECAUTIONS FOR BOATS MADE WITH METAL AND CARBON.....	10
4.5	POSITION AND INSTALLATION OF THE RADIO RECEIVER'S HOUSING	11
4.6	CHECKING THE RADIO TRANSMISSION FROM THE TRANSMITTERS TO THE RADIO RECEIVER	11
5	CONNECTION TO THE TOPLINE BUS AND TO THE NMEA BUS	12
5.1	CONNECTION OF EXTERNAL RELAYS	13
1	FIGURE 4	14
1.1	RED	14
5.2	ICOM ASN INTERFACE.....	14
6	RECEIVER INITIALIZATION AND PAIRING THE TRANSMITTERS	14
6.1	DESCRIPTION OF THE RADIO RECEIVER	14
6.2	ABOUT PAIRING	15
6.3	INITIALIZATION OF THE RADIO RECEIVER	16
6.4	COMPATIBILITY BETWEEN THE RADIO RECEIVER AND THE TRANSMITTER DISPLAY	17
6.5	ALLOCATE A NODE NUMBER TO THE <i>RADIO RECEIVER</i>	17
7	DIAGNOSTIC FOR 1ST LEVEL TROUBLESHOOTING.	18
8	TECHNICAL SPECIFICATIONS	19
9	RADIO RECEIVER FIRMWARE'S RELEASE NOTES.....	20

1 PRESENTATION

The **universal radio receiver** is an interface allowing the communication between **TOPLINE transmitters** and the **Gyropilot** or the **Multifunction displays**.

The transmitters control the **Gyropilot** and the **Multifunction displays**, via the **radio receiver** connected to the **TOPLINE BUS**. Each transmitter is paired with a code to avoid any interference with another system. It is possible to allocate **8 transmitters to the receiver** installed on your boat. Therefore, wherever you are, at the helm, next to the mast, or on the foredeck, the transmitters give you the control on the pilot and the displays.

Each transmitter features a safety function, which warns the crew with an audible alarm **should a crew member fall over-board**. This feature is called **MOB (Man Over Board)**.

Three types of **TOPLINE transmitters** communicate with the **universal radio receiver**:

- The **Remote Pilot** to control the pilot's course to steer and auto tack.
- The **Remote Display** to control the displays on the Bus (Multidisplay, Multigraphic).
- The **Remote Crew**, for the safety MOB function.

System description

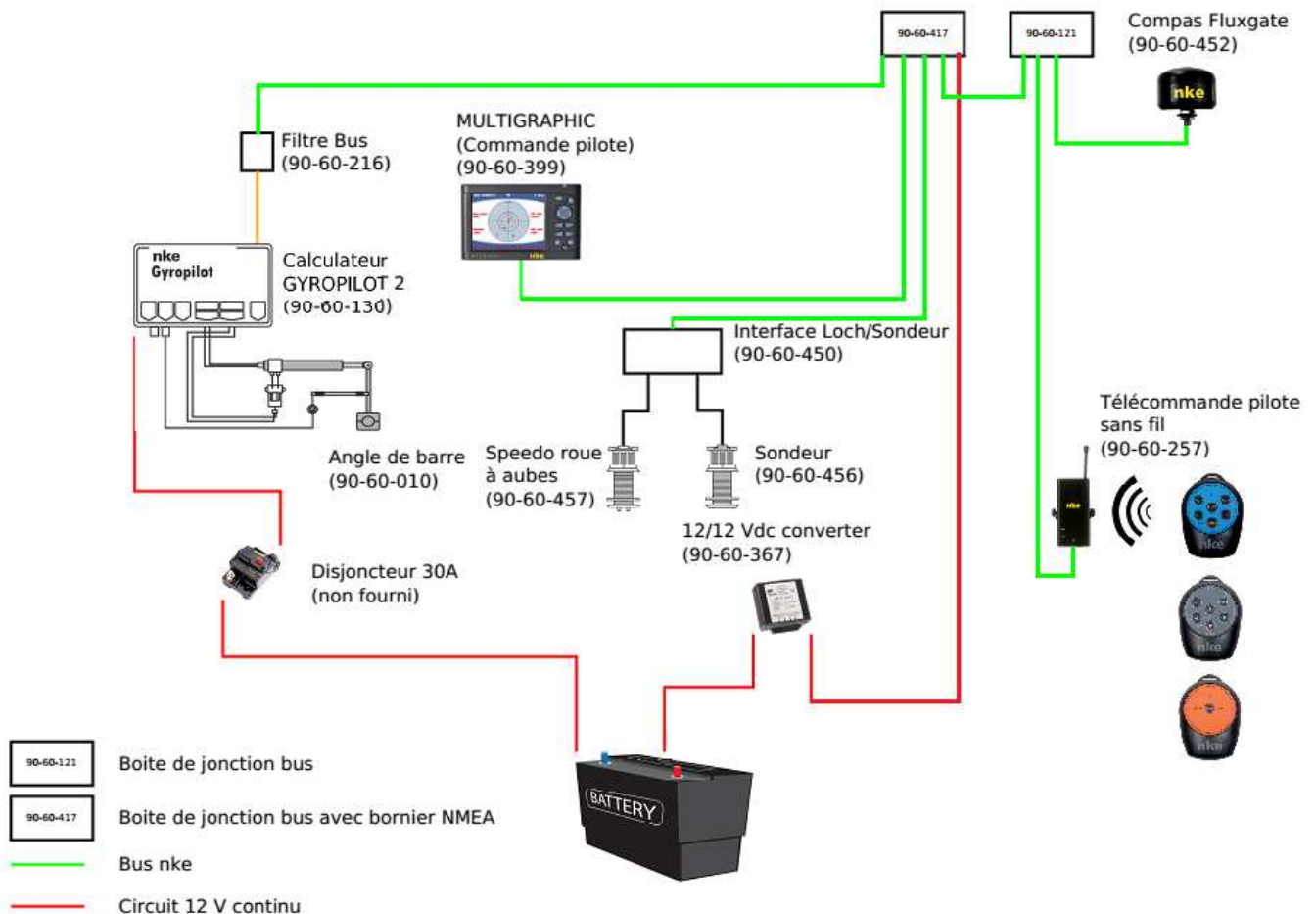



2 FUNCTIONS OF THE BUTTONS

2.1 Remote Pilot



- **Activation of the MOB monitoring**

To activate the MOB watch, press  and hold 7 seconds. As soon as the *radio receiver* acknowledges the activation of the MOB function, it generates an audible signal and the indicator flashes approximately every 2 seconds.

To deactivate the MOB watch press  and hold 7 seconds. The *radio receiver* makes 3 audible signals once it has acknowledged that the MOB function is disabled. When the MOB function is disabled, the indicator is off.

- **Enabling the "Man over Board" function manually.**

Press and  hold the button for 5 seconds to enable the MOB function.

Press on  to engage the *Gyropilot*.

Press on  to disengage the *Gyropilot*.

 to increase the course to steer 10° on port.

Tacking on port tack: press the button twice.

 to increase the course to steer 10° on starboard.

Tacking on starboard: press the button twice.

 to increase the course to steer 1° on port.

 to increase the course to steer by 1° steps on starboard.

2.2 Remote Crew



- **Activation of the MOB monitoring**

To activate the MOB watch, press  and hold 7 seconds. As soon as the **Radio receiver** acknowledges the activation of the MOB function, it generates an audible signal and the indicator flashes approximately every 2 seconds.

To deactivate the MOB watch, press  and hold the button for 7 seconds. The **radio receiver** makes 3 audible signals once it has acknowledged that the MOB function is disabled. When the MOB function is disabled, the indicator is off.

- **Enabling the "Man over Board" function manually.**

Press the  button 3 times to activate the MOB manually

2.3 Remote Display



▪ Activation of the MOB monitoring

To activate the MOB watch, press  and hold 7 seconds. As soon as the *radio receiver* acknowledges the activation of the MOB function, it generates an audible signal and the indicator flashes approximately every 2 seconds.

To deactivate the MOB watch, press  and hold the button for 7 seconds. The *radio receiver* makes 3 audible signals once it has acknowledged that the MOB function is disabled. When the MOB function is disabled, the indicator is off.

▪ Enabling the "Man over Board" function manually.

Press  and hold the button for 5 seconds to enable the MOB function.



for

- The selection of a display,
- Toggle lines on a TL25 or pages on the Multigraphic and Multidisplay displays

Procedure to select a display

Press  and hold (6-7 seconds) to enter the selection mode.

Once the TL25 is selected, its first line flashes press  to confirm the choice of that display.

When the Multigraphic or Multidisplay is selected, a yellow frame appears. Then press on the left or right arrow to toggle between displays. Press several times to select a display, and

confirm your choice with 



Allows the confirmation of the choices on the selected display.

- **Arrow keys (Navigator)**

Use the arrow keys to navigate in the different menus (left, right, up, down) of the selected display. For the TL25 Only the up and down keys are used to scroll the channels on the selected line.

3 MOB SAFETY FUNCTION

3.1 Operation

Each transmitter integrates a “**man over board**” safety function. When a person carrying a transmitter falls over board and the ship sails further than 50 metres away, the **MOB** alarm is triggered. The following functions are activated:

- **On display:** the estimated heading and distance to reach the man over board are displayed when a speedometer and a compass are connected to the **TOPLINE bus**. If your installation only comprises a speedometer, then only the estimated distance will be displayed.
- **The audible alarm:** There is a pre-alarm (discontinuous beeps) to warn that the coded sentences sent by the transmitter are no longer received. Then, a continuous audible alarm confirms the MOB alarm and the system triggers the procedure. By acknowledging the MOB function, one can stop the audible signal. Only by restarting the entire installation can you suppress the MOB page.

WARNING: It is a dead reckoning calculation based on the speed and direction (on water) vector. Draft due to current and wind is not taken in account for this dead-reckoning calculation.

3.2 Gyropilot behaviour

- In **crew** mode: the activation of the “**man over board**” function does not trigger any action on the **Gyropilot**.

- In **alone** mode:

The ship is equipped with a masthead unit and the gyropilot is set on “auto”: The **Gyropilot** automatically switches to **wind mode** and applies a “0°” set point, in order to position the ship into the wind.

If the ship is not equipped with a masthead unit: the **Gyropilot** automatically switches to “**rudder mode**”, and positions the helm with a +/- 40° set point in relation to the previous position of the helm.

3.3 The NMEA output

Two standard 0183 NMEA frames, relative to the “Man over board” function, are transmitted on the NMEA + output

\$ P M L R , 0 5 , 0 1 , 0 2 , 0 3 3 7 * 0 2 <cr>< lf> ; delay 150 ms

\$ T R W P L , , , , M O B * 2 1 <cr>< lf> ; delay 150 ms

\$ P M L R , 0 5 , 0 1 , 0 2 , 0 3 3 7 * 0 2 <cr>< lf> ; delay 150 ms

\$ T R W P L , , , , M O B * 2 1 <cr>< lf> ; delay 150 ms

\$ P M L R , 0 5 , 0 1 , 0 2 , 0 3 3 7 * 0 2 <cr>< lf>

3.4 Alarm relay



The **radio receiver** features two alarm outputs controlled via a relay. The relays can be used for:

- Trigger a **MAN OVER BOARD alarm**, i.e. an external horn,
- **Activate an emergency** beacon.
- Turn off the engine power supply

If the MOB function is triggered, the relay's contact is done on the ground after **1 second** for **MAN OVER BOARD ALARM** AND AFTER **10 minutes** for **BEACON DEPLOYMENT**.

3.5 Enable and disable the MOB function.

Once the system is powered, you need to enable the "Man Over Board" function manually on each **transmitter**. If you proceed to restart when a transmitter is active, the **radio receiver** will generate a validation beep, within a minute after the restart and the MOB function will be enabled.

KEYS TO ENABLE OR DISABLE THE MOB FUNCTION					
Pilot transmitter					
Display transmitter					
Crew transmitter					
	<table border="1"> <thead> <tr> <th>ENABLING MOB Monitoring</th> <th>DISABLING MOB Monitoring</th> </tr> </thead> <tbody> <tr> <td>Press the button for approximately 7 seconds until the indicator lights up. The indicator will flash every 2 s. and the receiver sounds a beep to acknowledge the MOB function, and a second beep to confirm the transmitter (1 minute max. between the two beeps)</td> <td>Press the button for approximately 7 seconds until the indicator lights up. The receiver has disabled the MOB function and generates 3 beeps.</td> </tr> </tbody> </table>	ENABLING MOB Monitoring	DISABLING MOB Monitoring	Press the button for approximately 7 seconds until the indicator lights up. The indicator will flash every 2 s. and the receiver sounds a beep to acknowledge the MOB function, and a second beep to confirm the transmitter (1 minute max. between the two beeps)	Press the button for approximately 7 seconds until the indicator lights up. The receiver has disabled the MOB function and generates 3 beeps.
ENABLING MOB Monitoring	DISABLING MOB Monitoring				
Press the button for approximately 7 seconds until the indicator lights up. The indicator will flash every 2 s. and the receiver sounds a beep to acknowledge the MOB function, and a second beep to confirm the transmitter (1 minute max. between the two beeps)	Press the button for approximately 7 seconds until the indicator lights up. The receiver has disabled the MOB function and generates 3 beeps.				

WARNING:

1. *Note that if you enable the MOB on the transmitter while the **receiver** is off power or out of radio range, this function will not be immediately implemented: it will be active once the **receiver** is turned on and in range.*
2. *When the MOB function is enabled, the transmitter consumes more energy. To save the battery life, we suggest enabling that function only at sea.*
3. *If the receiver is out of range of the transmitter, i.e. when you walk out of the boat on the pontoon, the MOB alarm is triggered.*

3.6 Automatic deactivation of the MOB function.

If it has not been used for a long period of time, such as a week without pressing any buttons, all transmitters automatically disable the MOB stand-by.

3.7 Suspending and disabling the alarm

To suspend the audible alarm (during the recovery operation of the man over board, for example), press any key on your transmitter. The estimated heading and distance to reach the man over board remain on display.

To disable the “Man over board” alarm, you must cut off the power supply of your **TOPLINE** installation.

Note that if you do not cut off the power supply, the information on heading and distance to the “**man over board**” are saved to the memory, no matter what commands are performed on your **TOPLINE** installation.

4 RECEIVER AND OFFSET ANTENNA INSTALLATION

4.1 Packing list for the receiver 90-60-250

- One radio receiver equipped with 3 metres of cable.
- One mounting bracket.
- One external receiving antenna with a 5 metres cable.

4.2 List of accessories

- External antenna: 90-60-277
- **Remote Pilot** transmitter: 90-60-247
- **Remote Display** transmitter: 90-60-248
- **Remote Crew** transmitter: 90-60-251
- TOPLINE terminal box: 90-60-121 or 90-60-417 (with NMEA input).
- **TOPLINE bus** cable 20-61-001.

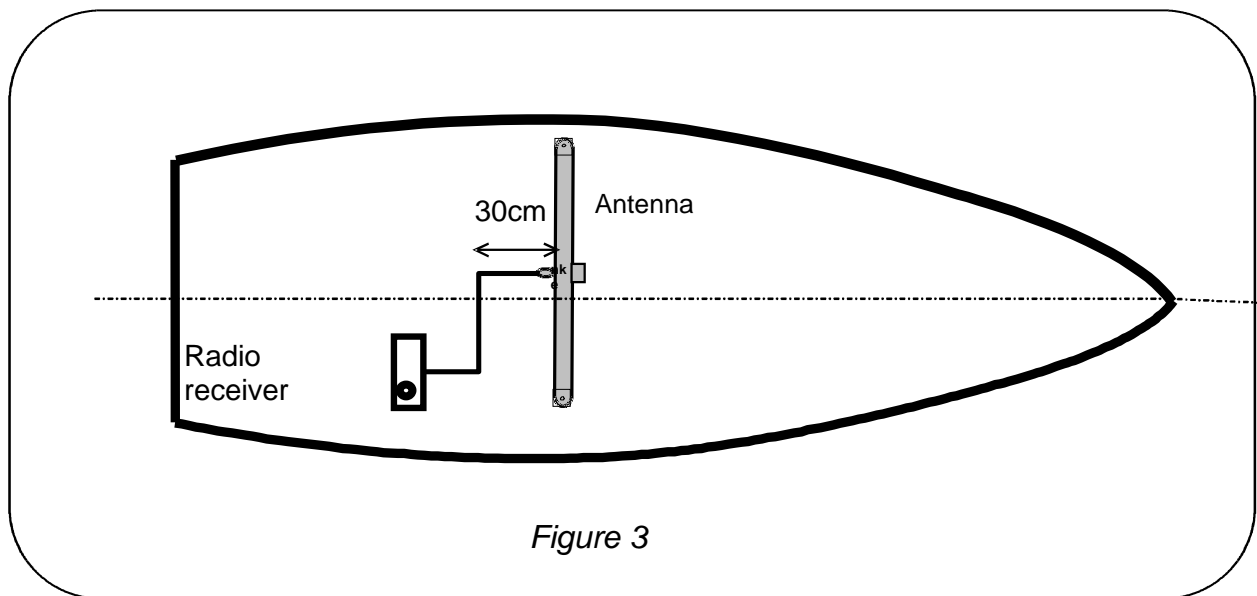

Figure 3

4.3 Specific precautions for the installation of the radio system

On the boat, the **nke** radio system comprises:

- One receiver equipped with a small antenna.
- One outside antenna.
- One or more **TOPLINE** radio transmitters.

The propagation of radio waves, emitted by the transmitters to the receiver antennas, can be more or less disrupted by the boat and its equipment. In order to achieve good radio transmission, it is thus important to pay close attention to the location of the antenna and the radio receiver. Figure 2 below describes the radio spectrum of the external antenna. We observe that wave reception is at its maximum perpendicular to the antenna, and lower towards the extremities. Position the outside antenna so that the spectrum covers the deck of your boat as much as possible.

We recommend the optimum configuration here below:

- The external antenna is positioned horizontally and perpendicular to the axis of the boat.
- The antenna is placed at the centre of the area where the transmitters are used.
- The cable outlet of the antenna must run perpendicular to the antenna, over a length of at least 30cm.
- The receiver housing and its antenna are positioned vertically.

4.4 Specific precautions for boats made with metal and carbon

Boats made with metal (steel, aluminium, etc.) and carbon, are sometimes impervious to radio waves. Thus we recommend that you install the external antenna outside above deck. The **radio receiver** must be installed down below.

Moreover, when the mounting bulkhead is made of metal or carbon, it is necessary to fit an isolation (wood or plastic) of at least five centimetre thick between the antenna and the bulkhead (see figure 4).

4.5 Position and installation of the radio receiver's housing

The receiver's housing is not waterproof, and must be located inside the boat, in a dry and protected place. The receiver is delivered with a mounting bracket. Attach the bracket on the bulkhead with 2 screws of 5 mm diameter (screws not included).

The radio receiver, equipped with a small antenna, must be mounted vertically.

4.6 Checking the radio transmission from the transmitters to the radio receiver

You have determined the locations of the radio receiver and external antenna. Before installing them definitively, check the quality of radio reception of your installation. In order to do that, use a **TOPLINE** radio transmitter and check that it can control your instruments, anywhere on the deck of the boat.

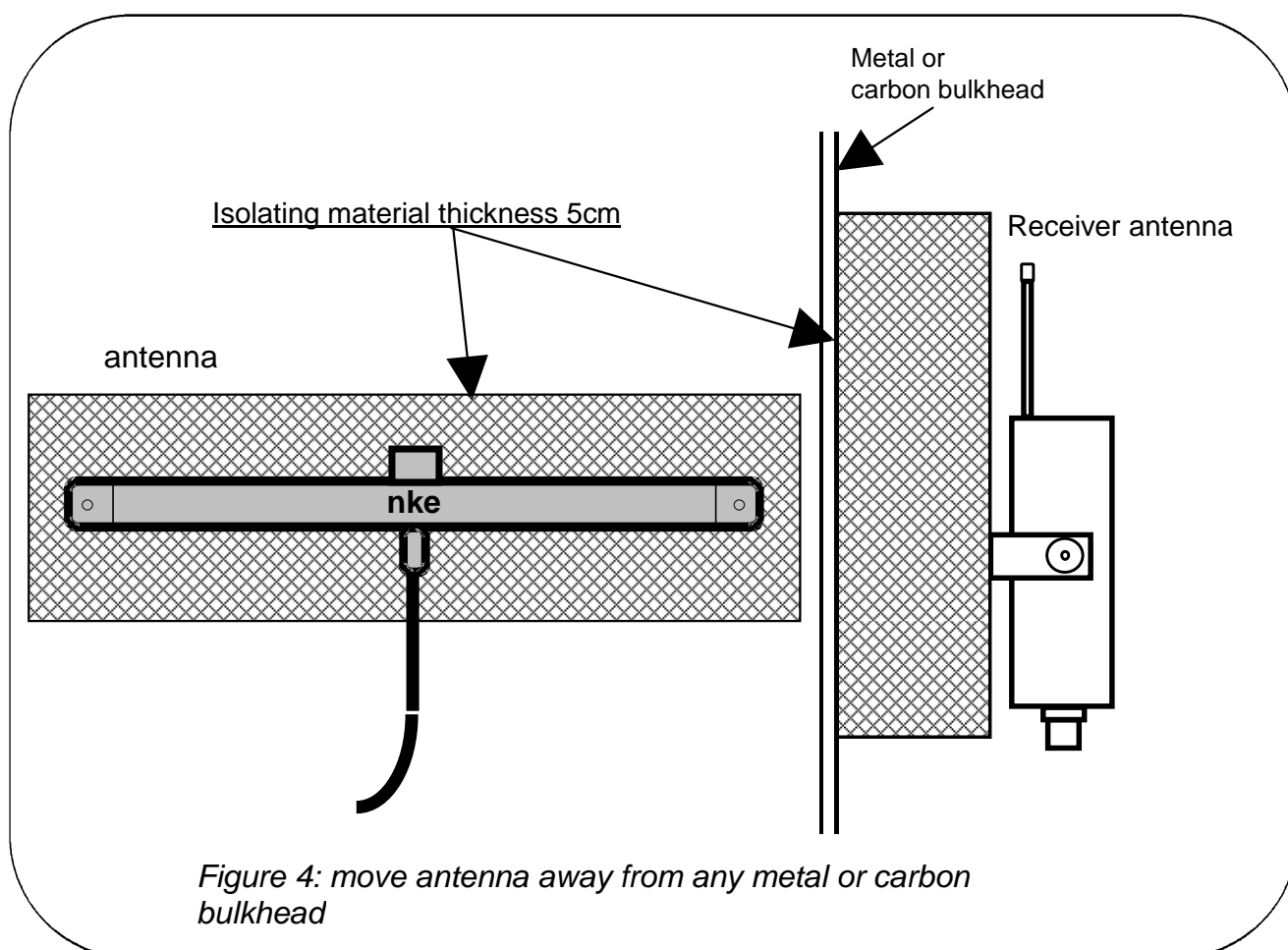

5 CONNECTION TO THE TOPLINE BUS AND TO THE NMEA BUS

1. Run the receiver bus cable to the **TOPLINE** terminal box of your installation.
2. Connect the bus cable inside the terminal box.

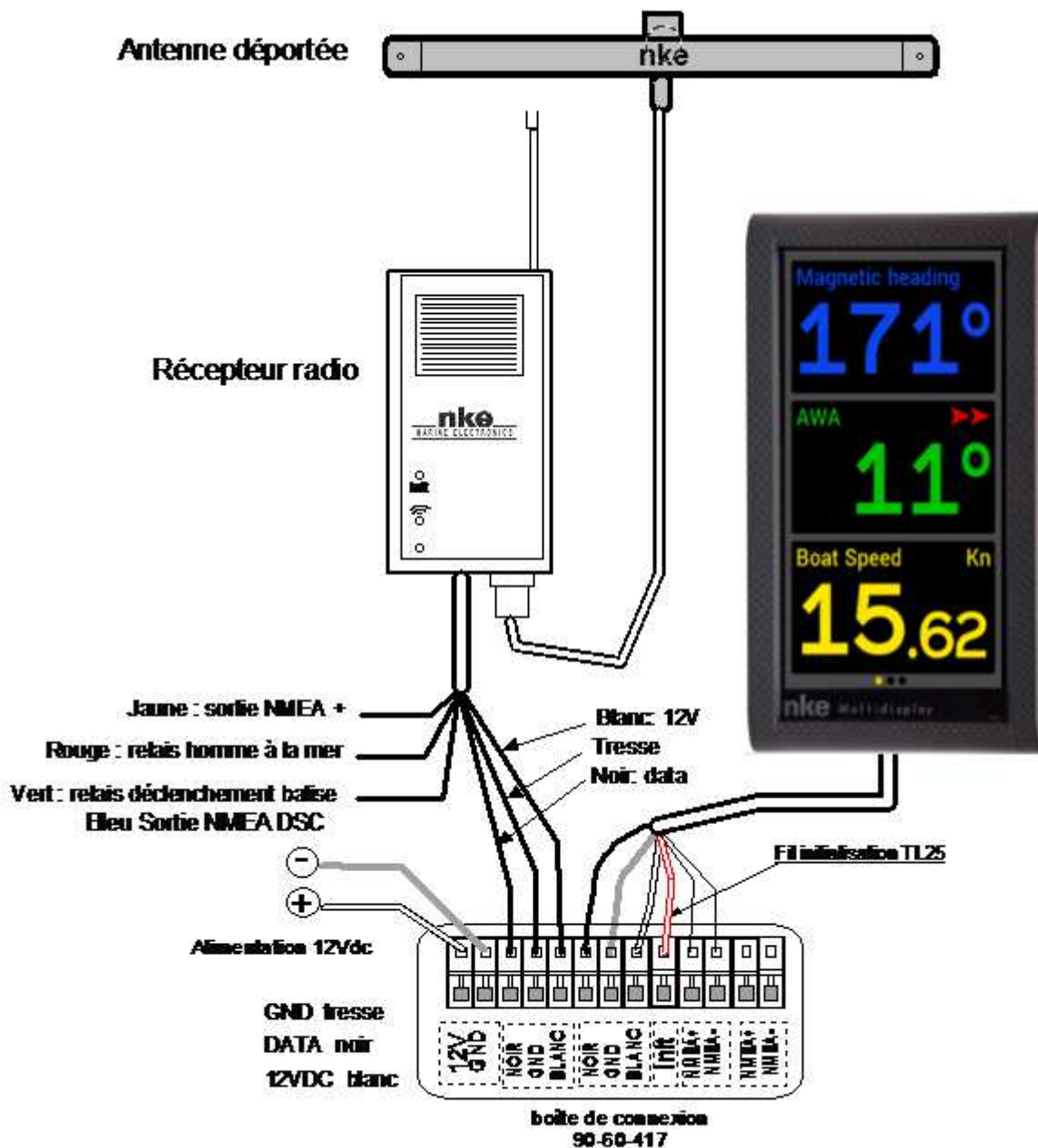

Figure 5 : raccordement au bus TOPLINE

If you shorten the bus cable, strip and tin the wires before connecting them to the terminal box.

CAUTION:

- The connection of the radio receiver must be carried out with the system power switched off.

Cable wires colour code

Receiver's cable wires colour code		Topline bus
Braid	Common ground to the Topline bus, the NMEA bus and relay contacts.	Braid
White wire	+12V	White
Black wire	Topline data	Black
Yellow wire	NMEA + output	
Red wire	relay contact Man Over Board alarm	
Green wire	relay contact beacon activation	
Blue Wire	DSC Output	

5.1 Connection of external relays

The radio receiver features two alarm outputs controlled by a relay. You can use this relay for:

- Trigger a **MAN OVER BOARD alarm**, i.e. an external horn)
- **Activate an emergency** beacon
- Turn off the engine power supply

If the "**Man Over Board**" function is enabled, the relay closes the contact on the ground, after 1 second (can be between 1 and 600 seconds with the maintenance software Toplink) for **MOB ALARM** and after 10 min for **BEACON ACTIVATION**.

The maximum current admitted by the relay is 1A.

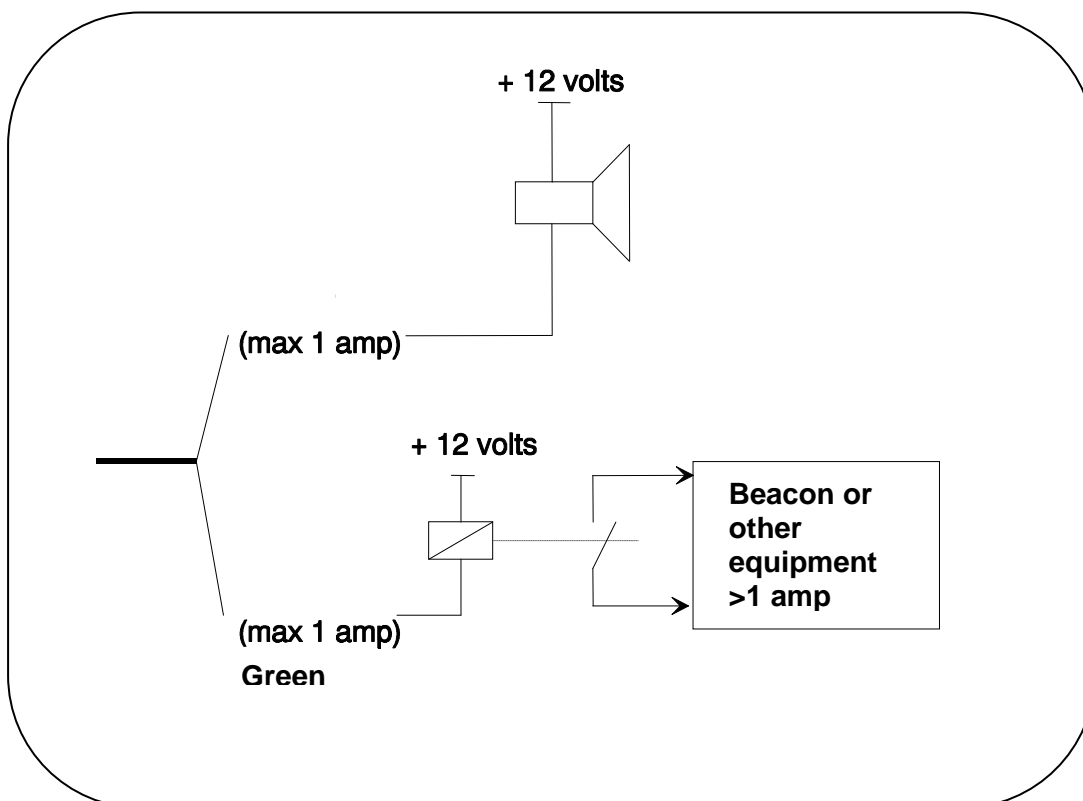

5.2 ICOM ASN interface

This model of radio receiver features a function which sends messages to an ICOM VHF. The blue wire is not connected to the ground, but used for that purpose. In order to identify various types of receivers, the logo on the front panel is in grey colour for all receivers of the new generation and featuring this function. This Data output is non-isolated. The Data+ is on the blue wire and - is connected to the Topline bus shield. This function is reserved for Figaro3.

6 RECEIVER INITIALIZATION AND PAIRING THE TRANSMITTERS

For the initialization of the radio receiver and transmitter(s) (**Gyropilot**, **Multifunction** and **crew transmitter(s)**) at first power-up, you must pair up the transmitter(s) with the **radio receiver**. This will allocate a node number on the bus.

The **radio receiver** is delivered with a default node number set as **0**. During the initialization, it will automatically insert itself in the list of instruments of the **TOPLINE bus** of your system, using a free node number comprised between **2** and **20**.

6.1 Description of the radio receiver

On the front panel of the **radio receiver**, you will find the "Init" push-button. Use a small screwdriver to actuate this push-button.

Underneath, two lights indicate the radio receiver status:

- The upper red indicator blinks when a transmitter communicates with the receiver. This indicator is permanently lit during the transmitter's pairing procedure.

- The bottom red indicator blinks when a transmitter communicates with the external antenna.

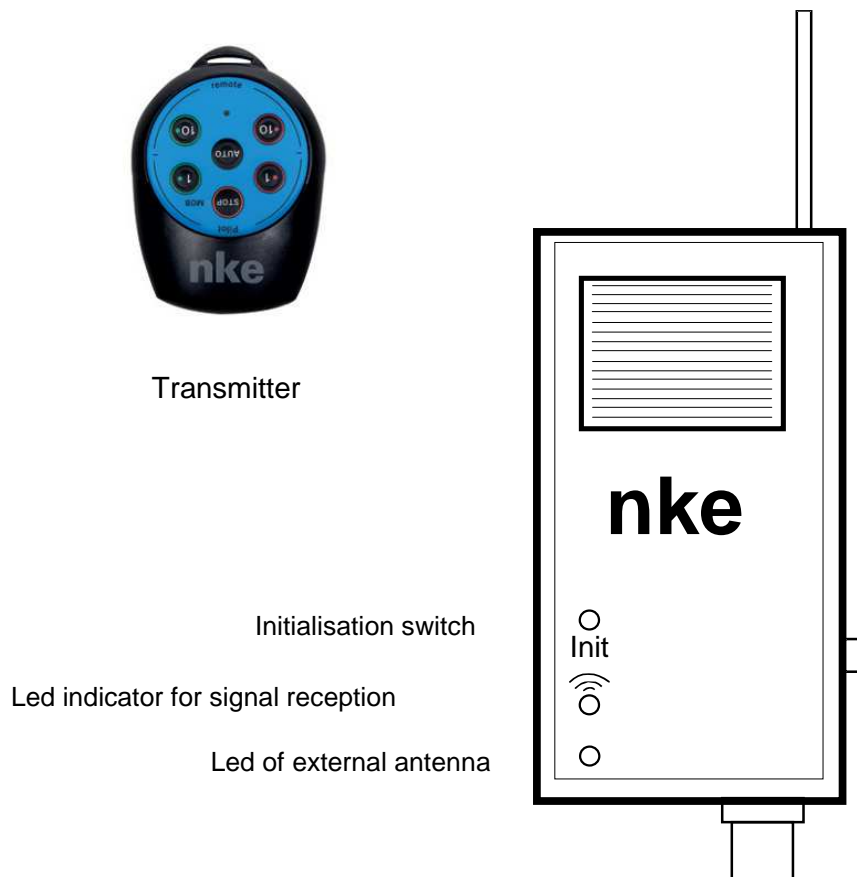

Figure 7: Radio receiver

6.2 About pairing

IMPORTANT:

- If the **Pilot transmitter** comes with a **wireless Remote Control**, this one is already factory default paired. Meaning you do not need to follow this procedure.
- Adding a new transmitter to an existing system means a new pairing of all transmitters is required.

Up to 8 transmitters can be paired. This pairing must be operated after having started the receiver's initialisation.

The initialisation procedure is explained here below:

- for the first commissioning of the **radio receiver** and the transmitters,
- for any addition of one or several **Pilot control** transmitters,
- To reset the system.

This procedure erases the setup memory and resets the receiver to default values.

6.3 Initialization of the radio receiver

- Press on "init", until the red indicator is permanently on, and then release the button.
- The receiver will beep every second, during one minute.
- During that minute, you have to pair the transmitters with the receiver.

Pairing a transmitter with the receiver:

	Key used for pairing
Pilot transmitter	
Display transmitter	
Crew transmitter	

- Press on the **key**, until you hear three "beeps", then release.
- Press and release the **key**.
- Press on the **key**, until you hear three "beeps", then release.

Once the pairing is successful, the **radio receiver** sounds a continuous "beep". In case of mistake, it sounds 3 short "beeps" and you need to pair the transmitter again.



- Pairing the next *transmitters*.

To quit the pairing procedure, press on "Init ", or wait one minute without pressing any key on the *transmitters*.

WARNING:

The MOB function must be disabled on the *transmitter* during the pairing procedure: messages transmitted from the transmitter to the receiver disturb the pairing. To do so, see paragraph 3.5

6.4 Compatibility between the radio receiver and the transmitter display

COMPATIBILITY Transmitter DISPLAY / RADIO RECEIVER			
TYPE OF RECEIVER	VERSION	Transmitter compatibility	Miscellaneous
	V3.1 and further	YES	Grey Logo "nke Receiver"
	Flash - versions V2.8 or older	YES after firmware update to V3.3	Yellow logo "nke Marine Electronics"
	Old model, no update possible	NO Radio receiver needs to be replaced	Yellow logo "nke"

6.5 Allocate a node number to the *radio receiver*

This operation allows the *radio receiver* to take an address on the TOPLINE bus:

- After pairing up the transmitter(s), press one of the keys of a transmitter,
- The master display indicates "**Creating list**" (the other multifunction displays indicate "**List**").
- An address is assigned to the *radio receiver*, and this address is saved to the memory.

Note that the *Remote Display* can only control *Multifunction* displays with a node number lower than the *radio receiver*.

7 DIAGNOSTIC FOR 1ST LEVEL TROUBLESHOOTING.

This chapter can help you rapidly resolve minor problems which do not require the intervention of a specialist. Before contacting technical support, please check the troubleshooting table below.

Problem	Possible causes and solutions
The Topline bus does not detect the radio receiver .	The bus cable is not or is badly connected to the terminal box: check the plugging and the connection inside the terminal box. Check the state of the cables: they must not show any sign of wear or cut.
The radio receiver emits an intermittent audible signal every 5 seconds.	The radio receiver stopped receiving the Topline Bus signal for more than 10 seconds: the bus cable is not or is badly connected to the terminal box: check the wiring and the connection inside the terminal box.
The Multifunction transmitter no longer acts on your displays.	- The radio transmitter is powered by a battery. The lifetime of the battery is 1 to 3 years. It may need to be replaced.
The Gyropilot transmitter no longer controls the pilot. The radio system is no longer operating.	- The transmitter is not paired with the radio receiver : perform the pairing of the transmitter (see chapter on initialisation).
The crew transmitter does not trigger the "Man Over Board" alarm.	- The radio receiver and its antenna do not receive the messages from the transmitter. Check that the offset antenna is properly connected to the receiver. Check that the antenna is not located near an object made with metal or carbon.

8 TECHNICAL SPECIFICATIONS

Radio receiver

- Range of the radio system: 25 metre radius.
- Frequency: 868,300 MHz
- Sensitivity: -100dBm
- Tightness of the housing: IP20. Non-waterproof housing.
- 3 metre cable.
- Weight: 260 g
- Operating temperature: -10°C to +50°C
- Storage temperature: -20°C to +60°C

External antenna

- Tightness: IP68
- 6 metre cable fitted with a BNC connector.
- Weight: 270 g
- Operating temperature: -10°C to +50°C
- Storage temperature: -20°C to +60°C



Transmitter

- Power supply: Lithium-battery 3.6V. Battery life: 1 to 3 years.

Send the unit back to your dealer for battery replacement Housing and keyboard will also be replaced.

- Waterproof protection rate: IP68, waterproof, immersed.
- Weight: 65 gr.
- Operational temperature: -10°C to +50°C
- Storage temperature: -20°C to +60°C

The radio receiver is in compliance with the EMC standards.

DECLARATION OF CONFORMITY <i>DECLARATION DE CONFORMITE</i> R & TTED 99 / 5 / EEC	
	
Manufacturer <i>Fabricant</i>	Micrel – Nke
Address <i>Adresse</i>	ZI de Kerandre Rue Gutenberg 56700 Hennebont France
Declare that the product <i>Déclarons que le produit</i>	
Name <i>Nom</i>	Universal Radio Receiver Récepteur radio universel
Reference <i>Référence</i>	90-60-250
Frequency <i>Fréquence</i>	868.300 MHz
Meets the essentials requirements according to article 3 of the following EC-Directive: <i>Est conforme aux exigences essentielles de l'article 3 de la Directive CE :</i>	
Directive 1999 / 5 / EC of the European Parliament and the council of 9 March 1999 on radio equipment and telecommunications terminal equipment and the mutual recognition of their conformity.	
Directive 1999 / 5 / CE du Parlement Européen et du Conseil du 9 Mars 1999 concernant les équipements hertziens et les équipements terminaux de télécommunications et la reconnaissance mutuelle de leur conformité.	
And that the following harmonised standards have been applied: <i>Et que les standards harmonisés ont été appliqués :</i>	
ETSI EN 300220 – 3 : 2000	
Hennebont 02-12-18 <i>Date & location / Date et lieu</i>	 Jean Pierre MAQUAIRE – CEO / P.D.G

9 RADIO RECEIVER FIRMWARE'S RELEASE NOTES

REV	Date	Information
V2.4	03/11/2008	<ul style="list-style-type: none">- Processor's compatibility- In Processor Mode, the remote control can no longer be used to tack or activate a MOB function.
V2.8	23/10/2014	<ul style="list-style-type: none">- Tacking function added with HR Pilot.
V3.1	21/11/2018	<ul style="list-style-type: none">- NMEA ASN output added on the blue wire of the new radio receivers.- Compatibility with Remote Display
V3.3	27/08/2020	<ul style="list-style-type: none">- Topline and AIS alarms added

Note: If you don't understand some points, or have some suggestions to improve this documentation, you can fill a note on <https://www.nke-marine-electronics.fr/> Thank you for your contribution.